



CDVI

Security to Access



V5SR

Ventouse électromagnétique appliquée
Monitored Surface mount Electromagnetic Lock
500 kg









FR EN







1] PRODUCT PRESENTATION

- **NF S61-937 - PV n° SD190043**
- **Surface mount**
- **High corrosion resistance**
- **Security rope**
- **No mechanical wear**
- **Ease of installation**
- **Recommended for interior use**
- **Fail safe** (Door unlocked when power off)
- **Holding force:** 500 kg
- **No residual magnetism**
- **Visual signaling** (Blue = Locked ; Green = Open)
- **Built-in varistor:** built-in electronic protection to eliminate back EMF
- **Dimensions (L x W x D):** 272 x 66 x 40mm
- **Armature plate dimensions (L x W x P):** 185 x 60 x 12mm
- **Power supply:** 12/24/48V dc
- **Consumption:** 480 mA @ 12V dc
240 mA @ 24V dc
120 mA @ 48V dc



2] PACKAGE CONTENTS

					
Magnetic lock	Armature plate	Fixing plate	Security Rope	5x16 Roll pin	4X10 Screw
1	1	1	2	2	1

					
4x25 Wood screw	Steel Rubber	Rubber washer	M8x35 Screw	M8x25 Screw	Cap nut
6	2	1	1	1	1

Manual
1

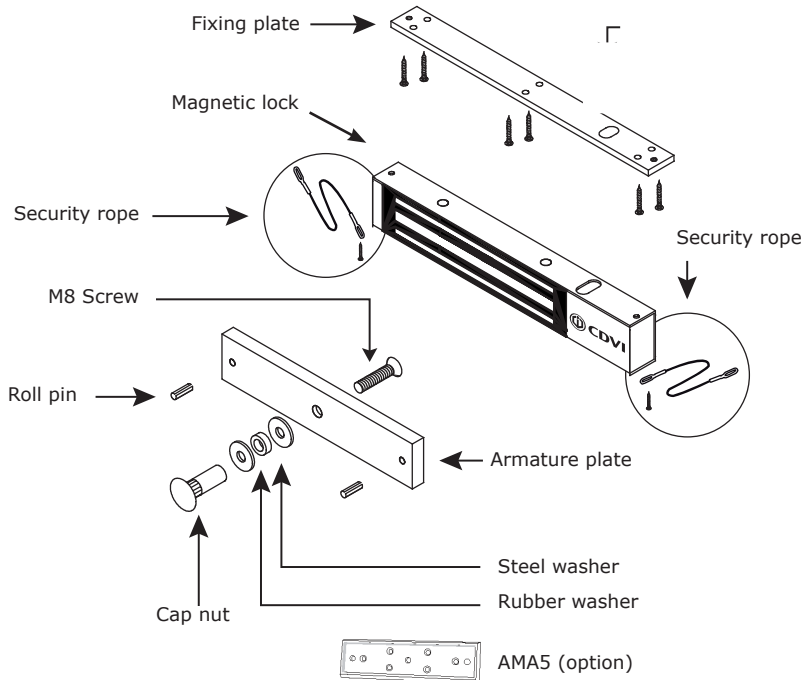

4] ELECTRICAL CONNECTIONS

Side load 100kg compliant.
Automatic voltage selection.

Requirements:

+ 12/24/48V dc
- 0V

Important information:

Respect the polarity.

Do not change the position of the jumper
except if using the Fire controller.
Refer to the Fire installation manual.

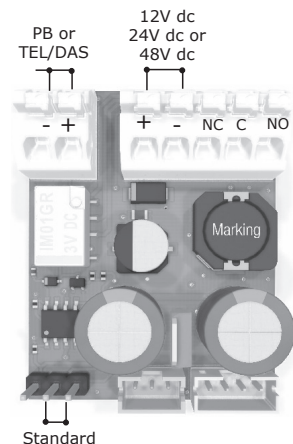

5] MOUNTING RECOMMANDATIONS

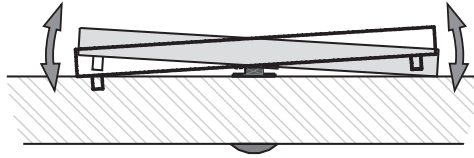

Armature plate

- It is vital that the magnetic lock and armature plate are securely fixed to their supports.
- The magnetic lock and the armature plate must be aligned.
- The armature plate must be mounted "floating" around the central mounting screw to compensate for any misalignment of the door.

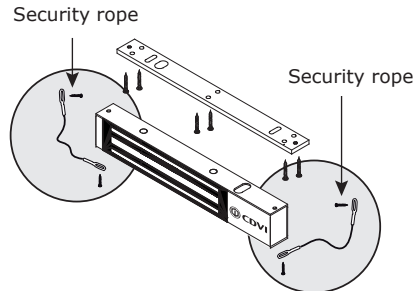

The security rope

Throughout its life, the magnetic lock is subject to an accumulation of repeated shocks and stresses at the fixing points on the frame, frequencies of opening/closing, (attempt to open a locked door and attempts at vandalism) which can cause it to become detached from the support when it is opened. In order to avoid the risk of the electronic lock block falling, install the two safety cables supplied to guarantee the safety of the users (see diagram above).

5] INSTALLATION

Installation on an outward opening door (Push Door)

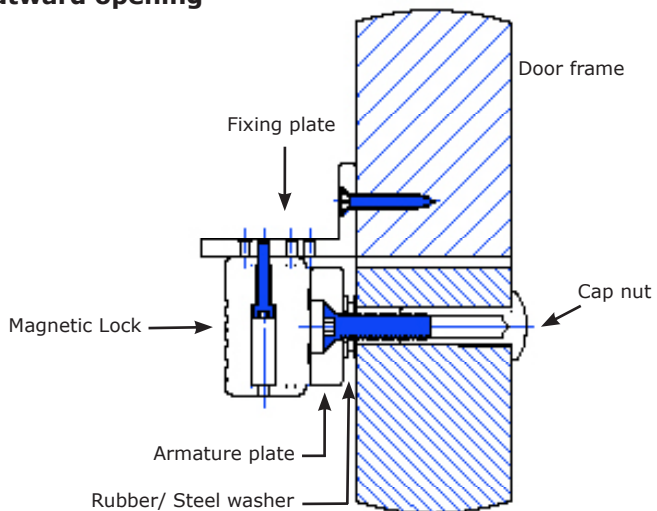

Installation on an inward opening door (Pull Door)

Installed with "Z" and "L" brackets

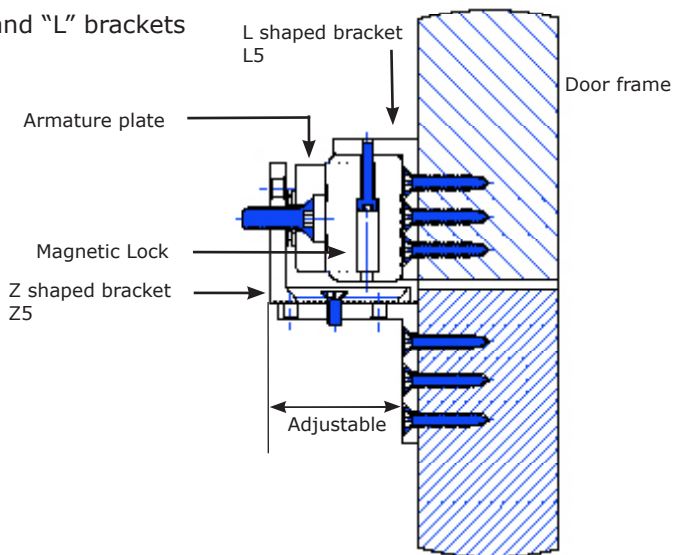

Installation on an outward opening door (Push Door) with Accessories

Installed with Armature housing AMA5

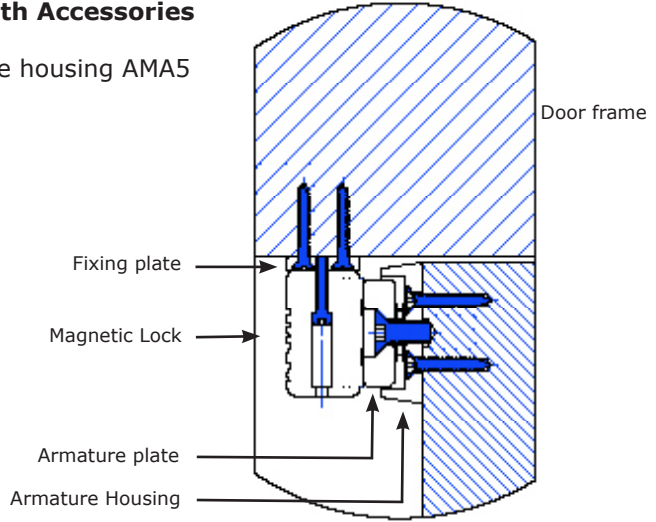

Installation on an inward opening glass door (Pull Door) with Accessories

Installed with "Z" and "L" brackets and UBK-P housing

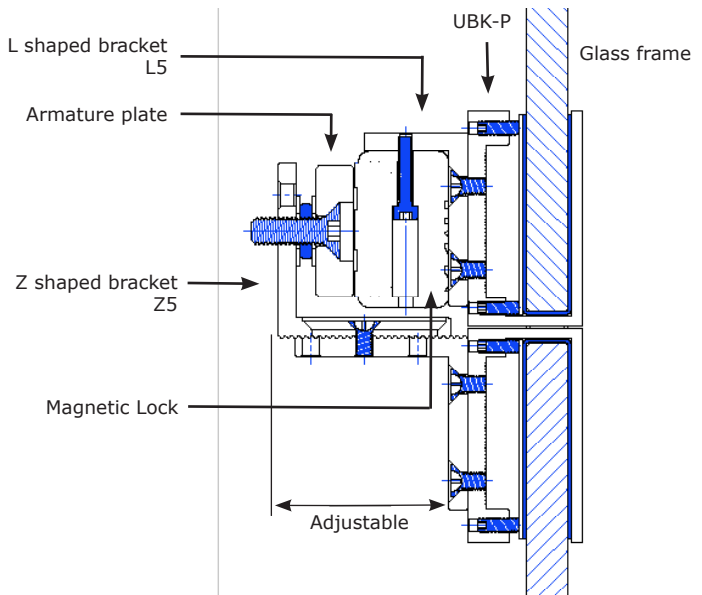

Installation with Accessories

DPM500 - Door position monitoring

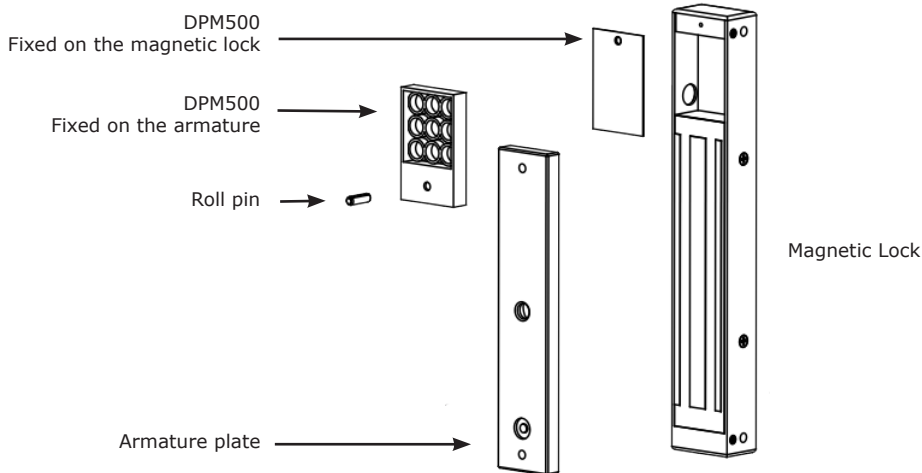

7] FAULT FINDING







Problem	Possible Cause	Solution
Door Locking impossible	The lock is not receiving DC current.	<ul style="list-style-type: none"> - Check that the wires are connected to the right terminals. - Check that the power supply is compatible. - Check that the lock is connected to the circuit correctly.
Holding force reduced	The lock and the armature are not lined up with each other.	<ul style="list-style-type: none"> - Check that the lock is connected to the circuit correctly. - Check that the electromagnet and the armature are properly aligned. - Check that the contact faces are free from dirt and rust. - Check that the armature is soft mounted.
	Low voltage or armature jammed.	<ul style="list-style-type: none"> - Check that the lock is receiving the correct power supply satisfactorily. - check the tightening of the armature and the condition of the rubber.
Faulty Reed switch	Voltage too low. Misalignment	<ul style="list-style-type: none"> - Check the power supply. - Cable cross section to be determined according to the power supply and the locking. - e.g.: $2 \times 1.5\text{mm}^2 \geq 10\text{m}$.







1] PRÉSENTATION DU PRODUIT

- **NF S61-937 - PV n° SD190043**
- **Montage en applique**
- **Résistance à la corrosion**
- **Filins de sécurité**
- **Pas d'usure mécanique**
- **Facilité d'installation**
- **Préconisée en intérieur**
- **Libère instantanément l'accès en cas de coupure de courant**
- **Force de rétention : 500 kg**
- **Pas de magnétisme résiduel**
- **Signalisation visuelle : Bleu = Fermé ; Vert = Ouvert**
- **Varistance incorporée : built-in electronic protection to eliminate back EMF**
- **Dimensions (L x W x D) : 272 x 66 x 40mm**
- **Dimensions contre-plaque (L x W x P) : 185 x 38 x 11mm**
- **Alimentation : 12/24/48V dc**
- **Consommation : 480 mA en 12V dc
240 mA en 24V dc
120 mA en 48V dc**



2] ÉLÉMENTS INCLUS

					
Ventouse saillie	Contre-plaque	Plaque de montage	Filin de sécurité	5x16 Goupille	4X10 Vis
1	1	1	2	2	1

					
4x25 Vis bois	Rondelle acier	Rondelle caoutchouc	M8x35 Vis	M8x25 Vis	Écrou borgne
6	2	1	1	1	1

Notice
1

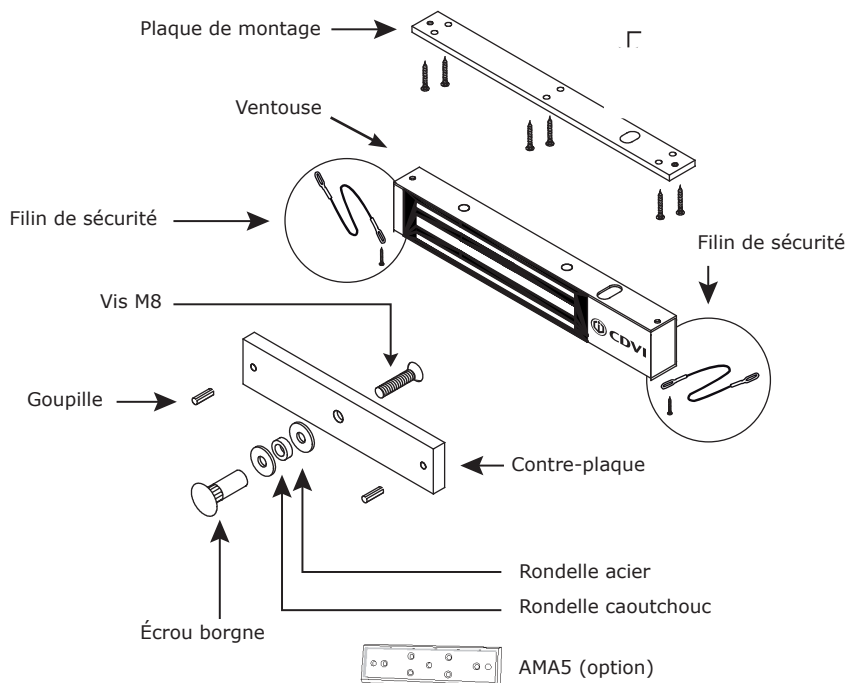

4] NORMATIF

La norme NFS61-937 exige d'alimenter la V3SR1248 avec une alimentation 24 ou 48V DC.

Sélection automatique de la tension.

Correspondance :

- + 12-24 or 48V dc
- 0V

Note importante :

Respecter les polarités.

Ne pas modifier la position du cavalier sauf si utilisation de l'entrée télécommande DAS

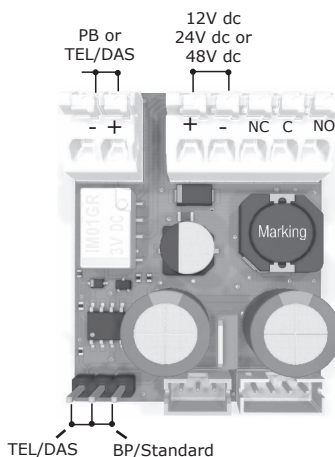

5] RECOMMANDATIONS DE MONTAGE

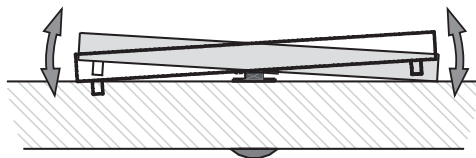

Contre-plaque

- Il est vital de fixer solidement la ventouse et la contreplaque sur leurs supports.
- La ventouse et la contre-plaque doivent être impérativement alignées.
- La contre-plaque doit être montée "flottante" autour de la vis centrale de montage pour compenser un mauvais alignement de la porte.

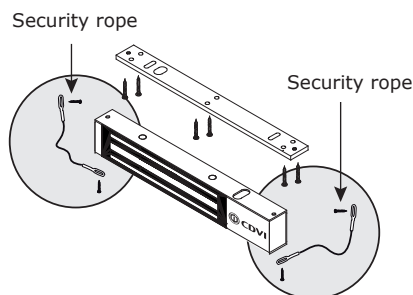

Les filins de sécurité

La ventouse électromagnétique subit tout au long de sa vie une accumulation de chocs répétés et de sollicitations aux niveaux des points de fixation sur le dormant, fréquences d'ouvertures/fermetures, (tentative d'ouverture porte verrouillée et tentatives de vandalisme) ce qui peut générer sa désolidarisation du support au moment de l'ouverture. Afin de pallier au risque de chute du bloc ventouse, installer les deux filins de sécurité fournis pour garantir la sécurité des utilisateurs (voir schéma ci-dessus).

5] INSTALLATION

Montage sur porte à ouverture extérieure (Poussante)

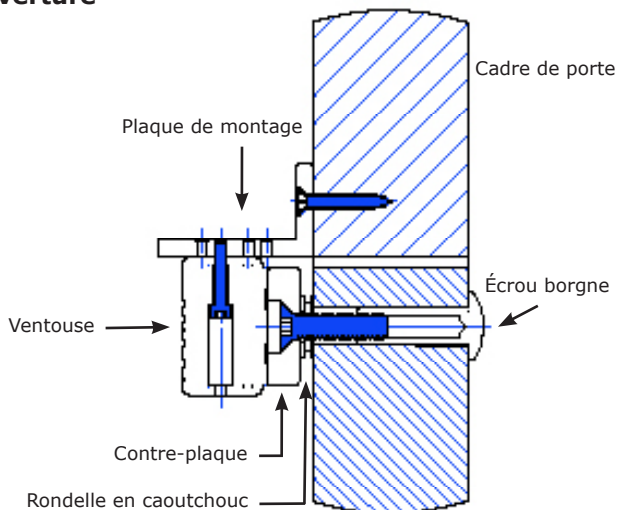

Montage sur porte à ouverture intérieure (Tirante)

Installé avec support "L" et "Z"

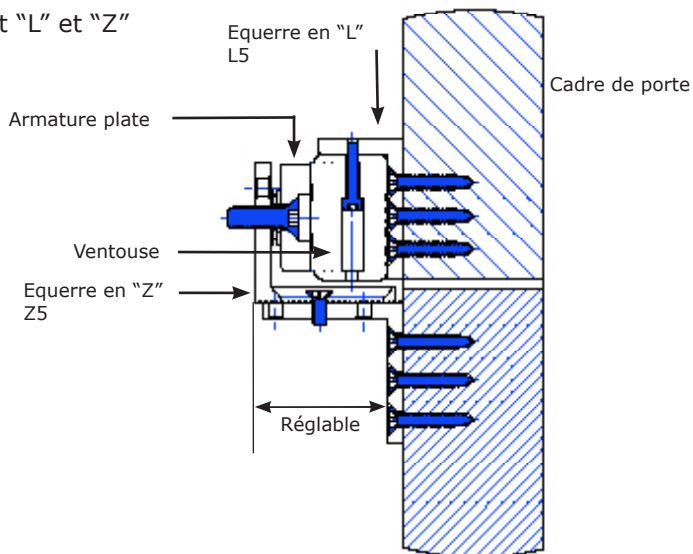

Installation porte à ouverture vers l'extérieur (poussante) avec Accessoires

Installé support de contre-plaque AMA5

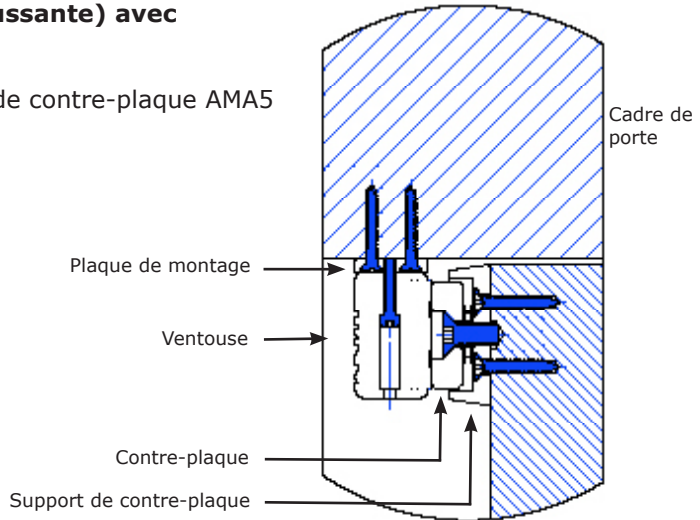

Installation porte à ouverture vers l'intérieur (Tirante) avec Accessoires

Installé avec support de contre-plaque "L", support universelle pour porte en verre UBK-P et support de ventouse "Z".

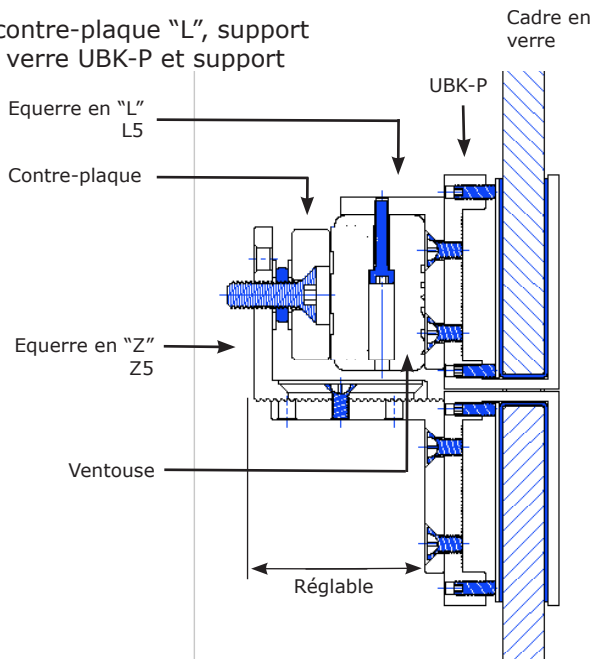

Installation avec Accessoires

DPM500 - Montage avec contact de position de porte

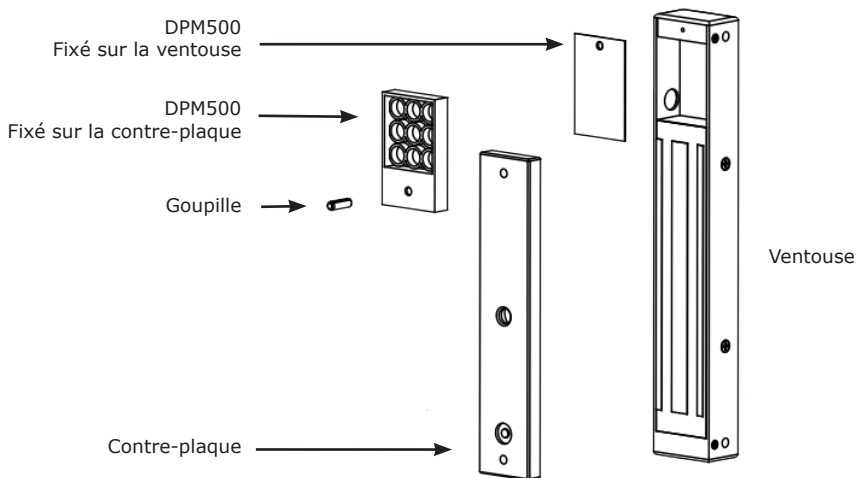

7] DÉPANNAGE

Problème	Cause Possible	Solution
Verrouillage de porte impossible	La ventouse ne reçoit pas de courant CC.	<ul style="list-style-type: none"> - Vérifier que les fils sont bien raccordés au bornier. - Vérifier que l'alimentation est compatible. - Vérifier que la ventouse est reliée correctement au circuit.
Force de maintien réduite	La ventouse et la contre-plaque ne sont pas en vis à vis.	<ul style="list-style-type: none"> - Vérifier que la ventouse est reliée correctement au circuit. - S'assurer que l'électroaimant et la contre-plaque sont bien en vis à vis. - Vérifier que les surfaces de contact sont exemptes de salissures et de rouille. - Vérifier que la contre-plaque est montée souple.
	Tension basse, contre-plaque bridée.	S'assurer que la ventouse est bien alimentée par la tension requise, vérifier le serrage de la contre-plaque et l'état du caoutchouc.
Commutateur Reed HS	Tension trop basse. Mauvais alignement.	<ul style="list-style-type: none"> - Vérifier l'alimentation. - Section de câble à déterminer selon la distance entre l'alimentation et le verrouillage. - ex: $2 \times 1,5\text{mm}^2 \geq 10\text{m}$



CDVI Group

FRANCE (Headquarters)
Phone: +33 (0) 1 48 91 01 02

.....

CDVI FRANCE + EXPORT

+33 (0) 1 48 91 01 02
www.cdvi.com

CDVI AMERICAS [CANADA - USA]

+1 (450) 682 7945
www.cdvi.ca

CDVI BENELUX [BELGIUM - NETHERLANDS - LUXEMBOURG]

+32 (0) 56 73 93 00
www.cdviBenelux.com

CDVI TAIWAN

+886 (0) 42471 2188
www.cdviChina.cn

CDVI SUISSE

+41 (0) 21 882 18 41
www.cdvi.ch

CDVI CHINA

+86 (0) 10 84606132/82
www.cdviChina.cn

CDVI IBÉRICA [SPAIN - PORTUGAL]

+34 (0) 935 390 966
www.cdviIberica.com

CDVI ITALIA

+39 (0) 321 90 573 - www.cdvi.it

CDVI MAROC

+212 (0) 5 22 48 09 40
www.cdvi.ma

CDVI NORDICS [SWEDEN - DENMARK - NORWAY - FINLAND]

+46 (0) 31 760 19 30
www.cdvi.se

CDVI UK [UNITED KINGDOM - IRELAND]

+44 (0) 1628 531300
www.cdvi.co.uk

CDVI POLSKA

+48 (0) 12 659 23 44
www.cdvi.com.pl

Toutes les informations mentionnées à titre indicatif sur le présent document (photos, dessins, caractéristiques techniques et dimensions) peuvent varier et sont susceptibles de modifications sans notification préalable.
All the information contained within this document (pictures, drawings, features, specifications and dimensions) could be perceptibly different and can be changed without prior notice.